



Drives



# Pump Drive F600

Simple, reliable flow control

Specialist Drive



**CONTROL TECHNIQUES**

**PUMP**

0.001	Master Access Level
0.002	Parameter Cloning
0.004 - 0.020	Parameter Setup
0.021 - 0.039	Control & PID Config
0.040 - 0.063	Pump Functions
0.064 - 0.065	PID Gains
0.066 - 0.067	Monitoring
0.077 - 0.078	Diagnostics

controltechniques.com/support

# Pump Drive F600

## The Specialist Pump Drive

From the drive specialists

Applications involving the flow of water demand extreme reliability and low energy consumption. Control Techniques' F600 drive, part of the Specialist series of industry-specific drive technologies, builds on our company's five decades of drives expertise, delivering precise, dependable flow control.

Everything you need is baked into the drive itself. The F600 packs all of the features you'll need, presented using terminology you'll understand. This isn't a generic drive with pump features tacked on; it's a dedicated, specialist pump drive, designed from the ground up to deliver the reliability and efficiency you need.

### 5-year warranty as standard\*



Our Pump Drive is so reliable we are confident enough to supply it with a five-year warranty as standard.

Now you can buy with the same confidence.

\*Warranty terms and conditions apply.

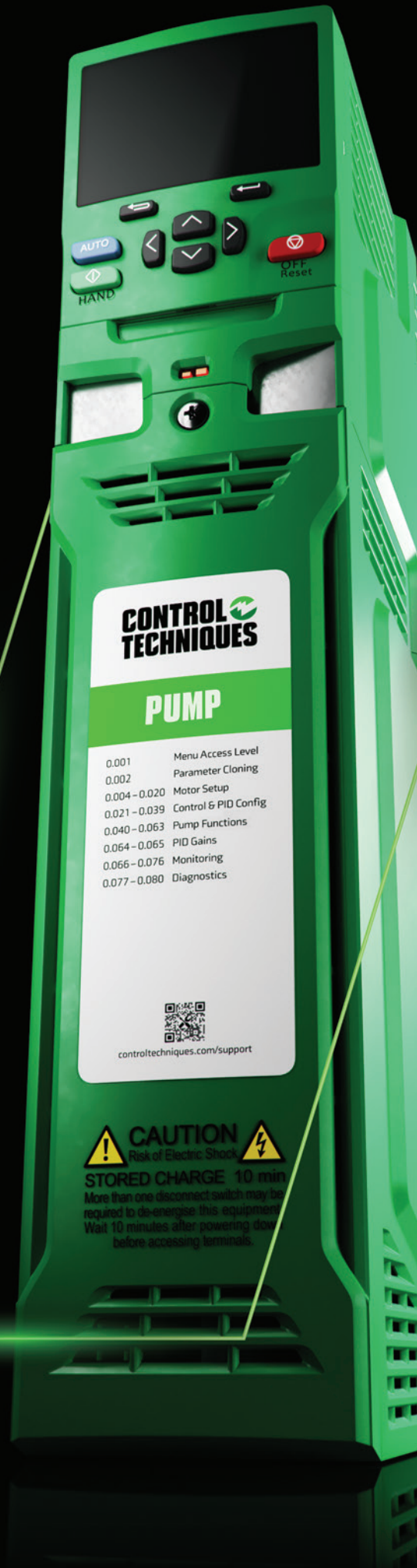

The perfect mix of application-specific features developed into a single solution



### Speaks your language

The F600 drive is tuned to suit your every need, optimised for minimal setup time yet sacrificing none of the flexibility. Whatever the challenge, our dedicated approach to clear parameter naming and structuring ensures we not only have the answers, but in a format you'll understand.



### Energy savings, unlocking the potential

On average, 85% of a pump's life-cycle cost is attributed to its energy consumption, therefore, optimising the energy usage can mean a significant reduction in the total cost of ownership. The F600 drive thrives on delivering more efficient ways of operating your variable torque application. You'll see the benefits in reduced running costs and lower energy requirements.



### Engineered for your application

The F600 Pump Drive offers a host of dedicated features including dry-run prevention, pipe fill, pump cleaning, over-cycling protection and level switch control. A range of different control modes covering single pumps and also different parallel pump configurations make Control Techniques' F600 a truly versatile solution.



### Total control

The F600 can also control the most efficient motors available, meeting IE5 efficiency levels, such as the Nidec Leroy Somer Dyneo+ hybrid permanent-magnet motor. With all of this combined, the F600 is your best choice to save you money every day.

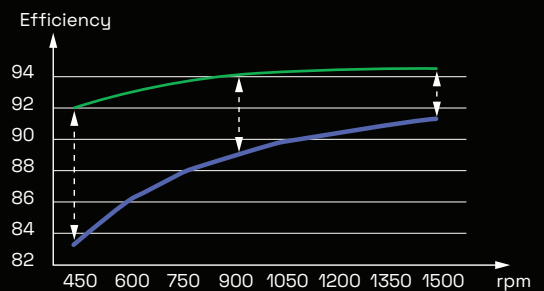

● AC PMA SynRM Dyneo+ ● AC IE2 IM with VSD



# Pioneering groundwater sprinkler system depends on advanced drives

Domina Inn and Conference Centre, located in Rotterdam, features a pioneering sprinkler system that uses groundwater pumped up from a sand layer 60 metres underground. Control Techniques AC drives were chosen to power the main and back-up pumps, due to the 'Fire' mode they offer, guaranteeing uninterrupted emergency operation.



# Unmatched Total cost of ownership

## With innovative protective features and extended equipment life

The F600 has comprehensive pump and motor protection features which minimise unplanned downtime, improving overall effectiveness and guaranteeing better value for money. Bring true resilience to your application and easily ride-through component failures.

### Automatic error recovery

In the unlikely event of detecting an error with your pump, the F600 has the ability to dynamically recover and resume normal operation.

### Limit protection

If the feedback exceeds the limits defined for your application, the F600 has the ability to raise an alarm or stop the drive to protect your equipment and preserve its lifetime.

### Transducer loss protection

In the event of losing connection to the transducer, the F600 can stop, continue to run at a fixed speed or ignore the fault depending on the application requirements.

### Fire mode

Fire mode allows the drive to disable all trips and to continue to run uninterrupted during emergency events if the application requires.

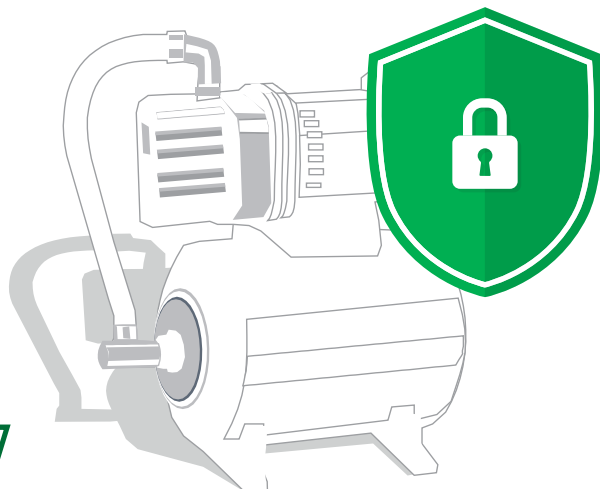

# Save on energy through A wide range of energy features

The F600 is 98% efficient, meaning very little energy is lost in power conversion.

Even more, the real savings potential gets unlocked by the F600's built-in features that can further reduce energy consumption:

### Low load savings

The F600 helps maximise energy savings when demand is low. Activating Control Techniques' leading-edge Low Load Power Saving function, the drive dynamically reduces the voltage applied to reduce losses in the motor and make the system more efficient.

### Sleep mode

When demand falls below a specified set-point the drive will automatically enter sleep mode and restart itself once demand rises above the set-point. Not only does this greatly reduce the amount of energy consumed, it also saves on equipment wear to preserve its lifetime.

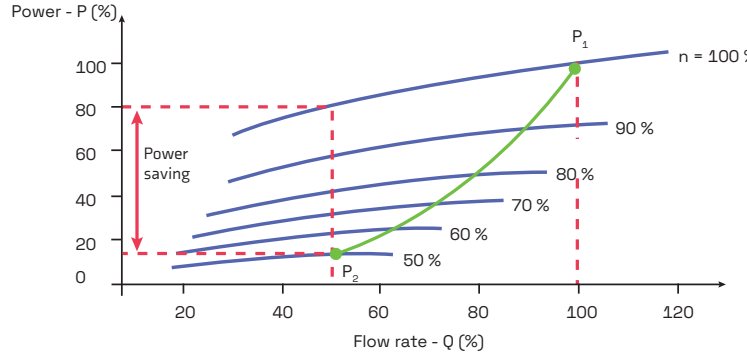
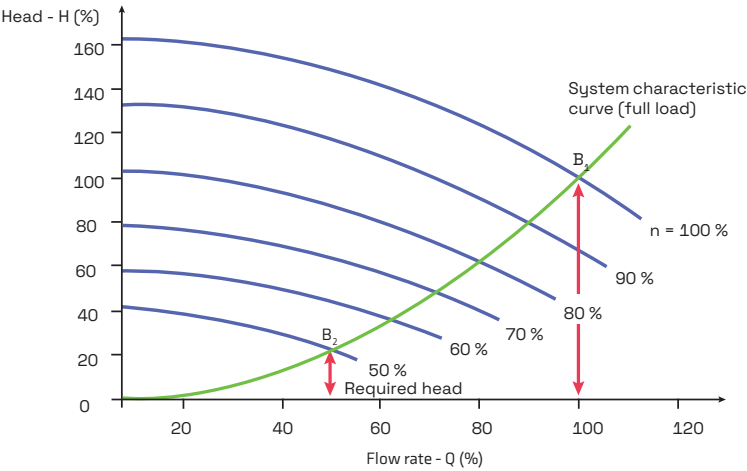





Drives provide unique cost-saving solution in the water industry

Byzak Limited, a Framework Contractor to Northumbrian Water, worked with Control Techniques to solve the problem of pump blockages at Seaton Sluice, near Whitley Bay, UK

## The F600 features optimised control for your flow applications

### Customisable units

Whether working with standard units of flow or pressure or an alternative feedback device, the F600 offers fully customisable units, to ensure the drive will always work seamlessly with your application.

### Pipe fill

Prevent spikes in pressure at start-up using a controlled ramp, to protect your piping system and the pump itself.

### Over-cycling protection

Optimise drive, motor and pump sizing, and regulate pump wear by limiting the number of start-stops per hour. Flexible configurations allow to dynamically alter cycling reference limits, set an alarm or stop the drive when a limit is reached.

### Cleaning

Live, continuous monitoring of the system is used to trigger an automatic drive-based cleansing cycle to clear the pump impeller and help avoid maintenance costs on cleaning pump blockages.

### Dry-run prevention

Prevent the pump running dry by checking the load against a threshold; with flexible configurations to dynamically adjust output, set an alarm or stop the drive.

### No-flow detection

Where there is no-flow or low-flow, the F600 drive can automatically enter sleep mode to save energy, based on the feedback of a pulsed flow transducer, or triggered by a flow switch, or detected by the software alone.

### Level switch control

Level switches provide critical protection for tanks in the event of the level reaching a “high” switch, whereby the pump is stopped, or a “low” switch, whereby the pump is started, to ensure pumping within tank levels.

### Flow compensation

Flow compensation offers energy savings in large water delivery systems, such as irrigation, where for practical reasons the pressure sensor must be fitted close to the pump rather than at the furthest point on the pipe system.

# Pump control modes

# Flexible support for every system

## Single pump

Control Techniques' Single Pump mode is an effective and versatile variable speed control solution for maintaining a constant set-point in a single pump configuration.

Fire mode allows the drive to disable all trips and to continue to run uninterrupted during emergency events if the application requires

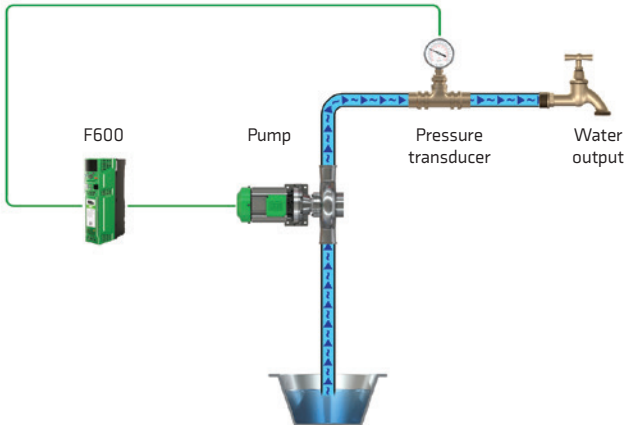

## Cascade

Cascade mode allows the F600 to operate with up to 4 assist pumps to aid the primary pump when required.

- Energy usage is optimised whereby the assist pumps are only enabled when demand reaches sufficient levels.
- Assist pumps are used alternately to apply uniform wear and increase pump availability.
- Over-cycling protection for assist pumps to control the number of starts and stops per hour.

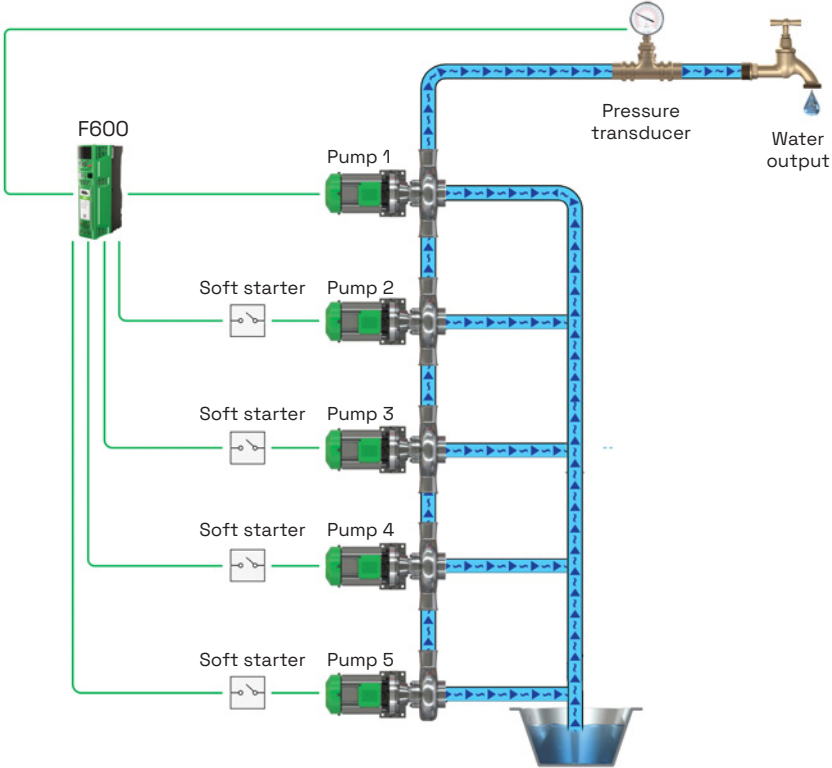







## Multi-leader

Complete control of your application with up to 3 x F600 drives and maximum energy savings with these variable frequency drives running parallel.

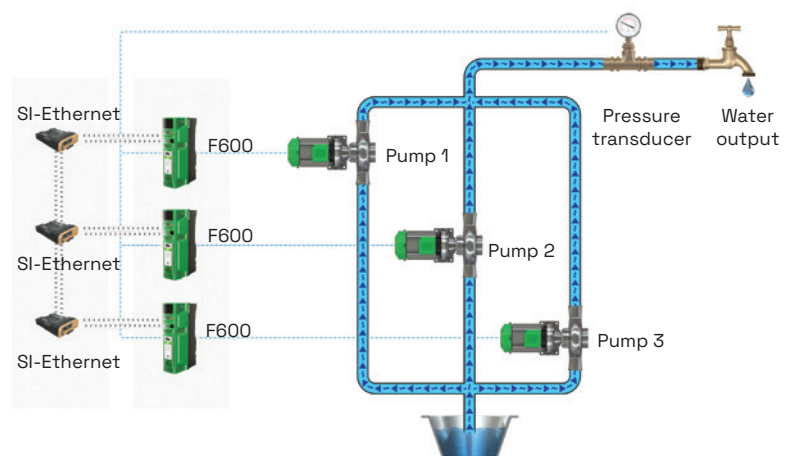
- The Multi-leader drive configuration provides redundancy and removes the need for a PLC.
- The “lead” drive is automatically cycled to apply uniform wear.
- If the “lead” drive loses its transducer, it can access the transducer feedback from another F600 in the system over Ethernet.
- Dynamic re-selection of “lead” pump if a pump is taken out of service or develops a fault.







# Simple commissioning For hassle-free, efficient installation

Install and go. Application-focused design and dedicated pump functions mean optimum performance can be achieved straight out of the box, with minimal set-up.

## Guided commissioning tool

Gain complete control of your drive with Control Techniques' Connect PC Software. The dedicated Pump Drive setup screens guide you through every step of quickly getting your drive up and running.

Everything is covered in a simple, logical format, from configuring your multi-pump system, through the input of motor characteristics, to setting up the PID process control loop. All the pump features are also readily available, providing intuitive setup with contextual help through a single tool.

## Single setup menu

Setup using only the keypad couldn't be easier. There's no need to waste time looking for all the parameters - we've grouped them all together for you in one, streamlined menu.

All relevant parameters are literally at your fingertips to easily configure and monitor your application.

All additional parameters are still accessible through the advanced menus, for un-precedented control and fine tuning.

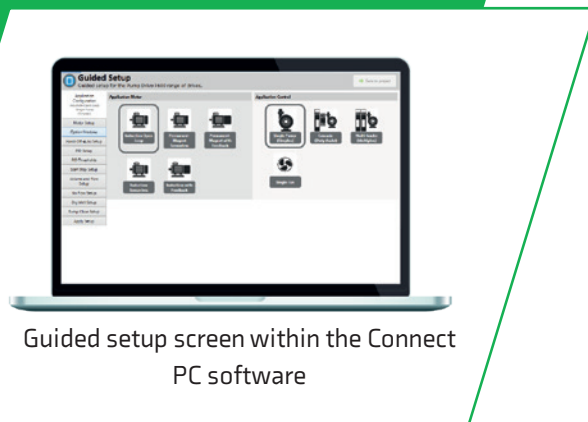

Guided setup screen within the Connect PC software



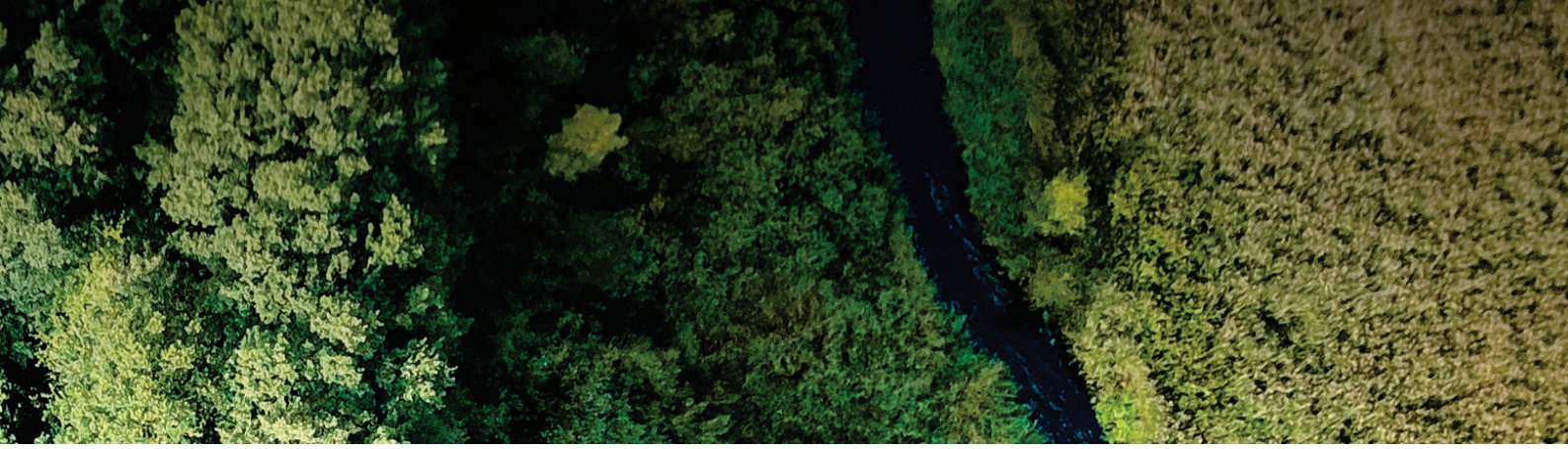

# Free standing drive range

Ready to use pre-engineered high power drives

## Highly efficient pre-engineered motor control system

Control Techniques' Free Standing Drive optimises motor energy efficiency and comes ready to use, pre-assembled in its own industry-standard cabinet with all necessary system components included. The Pump Drive F600's Free Standing Drive variant complements and extends the product range, while having all of the core product's capabilities and features.

## No extra engineering required

The Free Standing Drive fits a small footprint, and it's easy to integrate with common cubicles, including as standard: load switch, fuses, fan, line and sharing chokes and cabling. The cabinet can also come with a door-mounted HMI with Real-Time Clock, for easy set-up and maintenance.

Thanks to the dedicated online configurator, getting a quote and ordering is as simple as can be. Even more, we can ship your Free Standing Drive to you at very short lead times, saving weeks on typical industry standards.

## Light weight, but no light weight!

The F600 is also available with Control Techniques' largest frame, which not only offers 500 kW of power in a single module, but at 130 kg is up to 60 kg lighter than competitor drives. Its small footprint and pre-engineered accessories make it easy to install or retrofit in industry-standard cubicles.

Please see the Drive Free Standing brochure for more information.

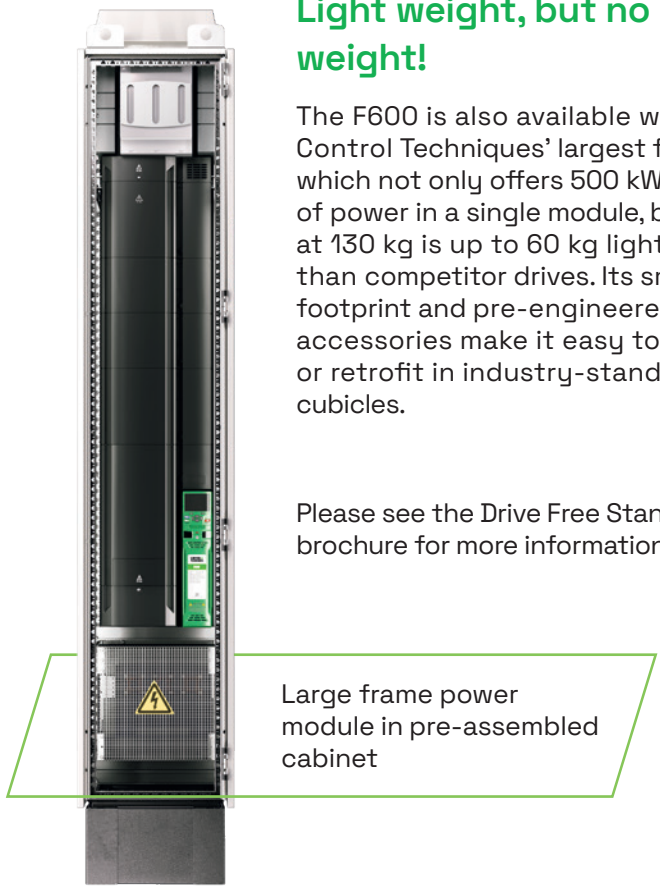

# Dust and water resistant Pump Drive F600 High IP variant

The Pump Drive F600 offers a full IP65 solution with exactly the same dedicated pump features & capabilities as the standard models.

IP65 provides protection from total dust ingress and low pressure water jets from any direction, making it a simple choice for harsh environments and the outdoors\*. The Pump Drive F600 is now one of the most protected drives on the market, maximising pump uptime and productivity, while cutting maintenance costs.

## Standard and High IP drives

The High IP drive will already be familiar to users of the F600, with all the same features that make commissioning effortless. The Hand-Off-Auto keypad with the built-in real-time clock is still available, sealed, and the protective casing has been designed with easy servicing and usability in mind.

This new variant enables customers to use both standard and high IP drives for the same project, so there is no longer any headache with mixing-and-matching vendors or product feature sets, making project qualification straightforward.

## Save on installation

The F600 High IP drive is enclosed in a sturdy, protective yet light casing, providing a compact solution. This not only allows easy integration in harsh environments but wall mounting close to the pump reduces installation costs, through:

- No cabinet required
- Shorter cable lengths
- Less labour time/cost to install drive

## 5-year warranty as standard\*

Our Pump Drive High IP is so reliable we are confident enough to supply it with a five-year warranty as standard.

Now you can buy with the same confidence.

\*Warranty terms and conditions apply  
Shading from direct sunlight is required.



# Control Techniques

# PC Tools

## Energy savings estimation

Control Techniques' energy optimisation software helps you analyse energy usage for flow applications and quantify the cost savings of using your Control Techniques drive.

- Estimation of energy usage using Control Techniques variable frequency drives for pump applications.
- Identify the payback period through the energy savings from using a Pump Drive F600 over conventional control methods.
- Graphical representation of flow versus cost, hours and time.

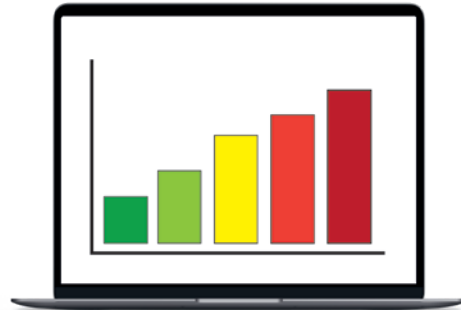
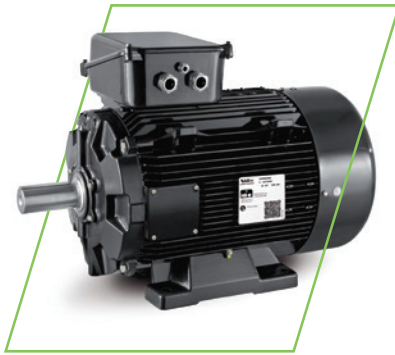

Free  
download

## Diagnostic Tool

The Diagnostic Tool App is a fast and simple tool, which allows users to quickly solve any error codes that the drive may show. Built within the app are easy to locate wiring diagrams for first time setup and fault finding with links to the relevant comprehensive manuals.

The app also has full contact details of the technical support teams around the world to aid you with technical assistance.

Available for iOS, Android and Windows™, download the app for free at [www.controltechniques.com/mobile-applications](http://www.controltechniques.com/mobile-applications)



\*For Microsoft users, please note that this mobile app operates with Windows 10 only.



# F600 HMI

The dedicated F6 HMI panel provides the ultimate interface for configuring and monitoring your Pump Drive F600.

Designed specifically for pumping applications, the F600 HMI supports configuring the F600 in Single Pump, Cascade and Multi-leader modes, connecting via Modbus RTU or Modbus TCP/IP with the option for remote access via the OPC-UA protocol.

The pre-configured pages are comprehensive in supporting drive configurations, application configurations, pump control and more. With access to PID monitoring and historic trends, the F600 HMI allows real-time access as well as analysis in an intuitive, simple to understand graphical interface.

The out of the box setup is bursting with features, but can also be tailored to suit specific applications where further customisation is required.

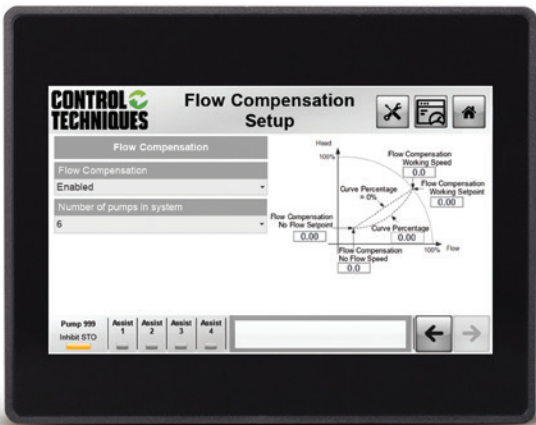

## F600 HMI compatibility

	Modbus RTU	Modbus TCP
Single-pump	✓	✓
Cascade	✓	✓
Multi-leader		✓

## Modbus RTU

The simplest method of communication with an F600 HMI is via the built-in F600 RS-485 connector using Modbus RTU, requiring no additional components.

Simply connect the F600 to the HMI and go.

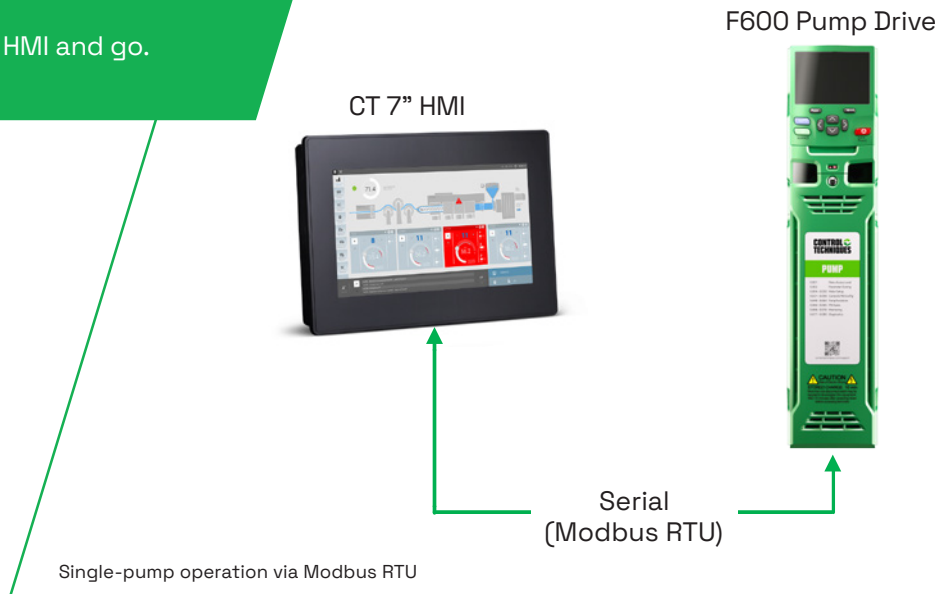

## Modbus TCP/IP

Using SI-Ethernet module(s) with Pump Drive F600 allows communication via TCP/IP and operating in Multi-leader mode, the most robust of the three operating modes.

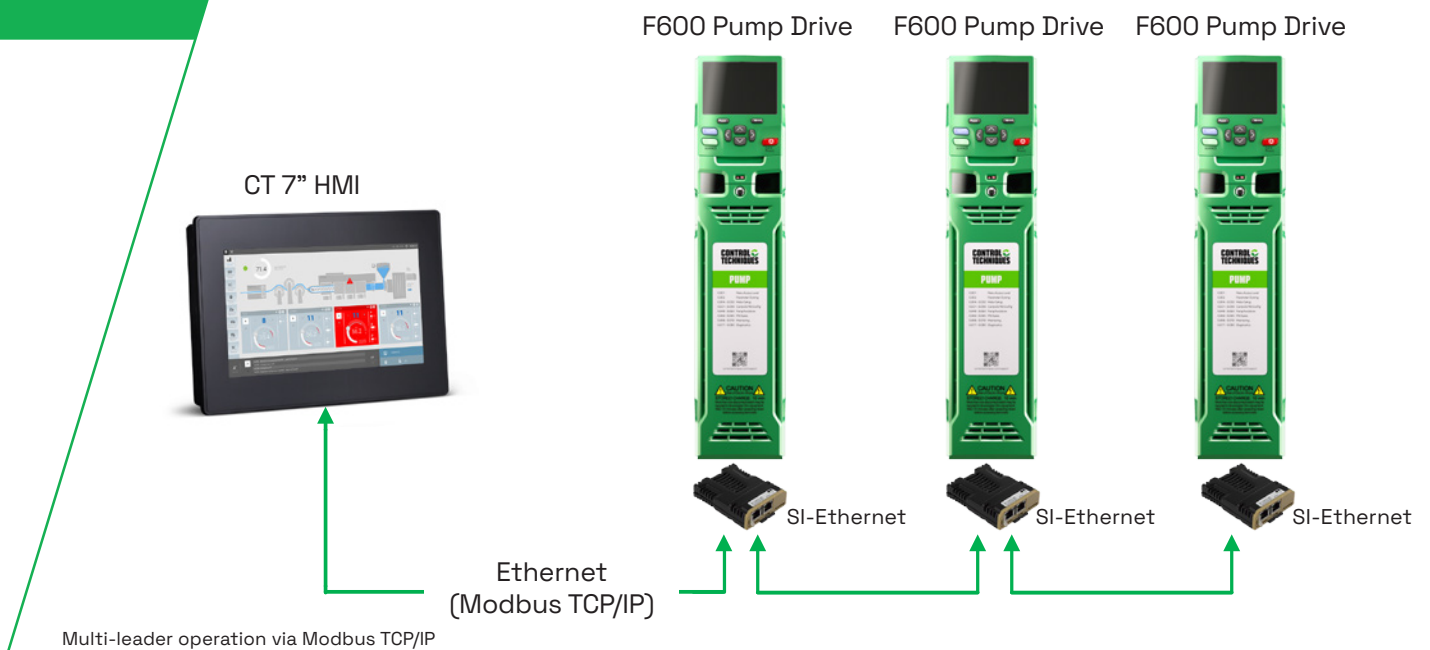











**Slot for Smartcard/SD card for parameter storage and cloning**

**Easy click-in keypad connector**

**Multi-language LCD keypad**  
 With Hand, Off and Auto controls and built-in real-time clock for run time scheduling

**3x System Integration (SI) module slots for communications and I/O\*\***

**Onboard I/O**

2 x analog inputs	3 x configurable digital I/O
2 x analog outputs	2 x form C relay outputs
3 x digital inputs	1 x Safe Torque Off (STO) input

\*\*SI-I/O option provides additional 4 x digital I/O, 3 x analog inputs (default)/digital inputs, 1 x analog output (default)/digital input, 2 x relays

**User-friendly pluggable control connections**



\*Features and their locations vary on some drive sizes



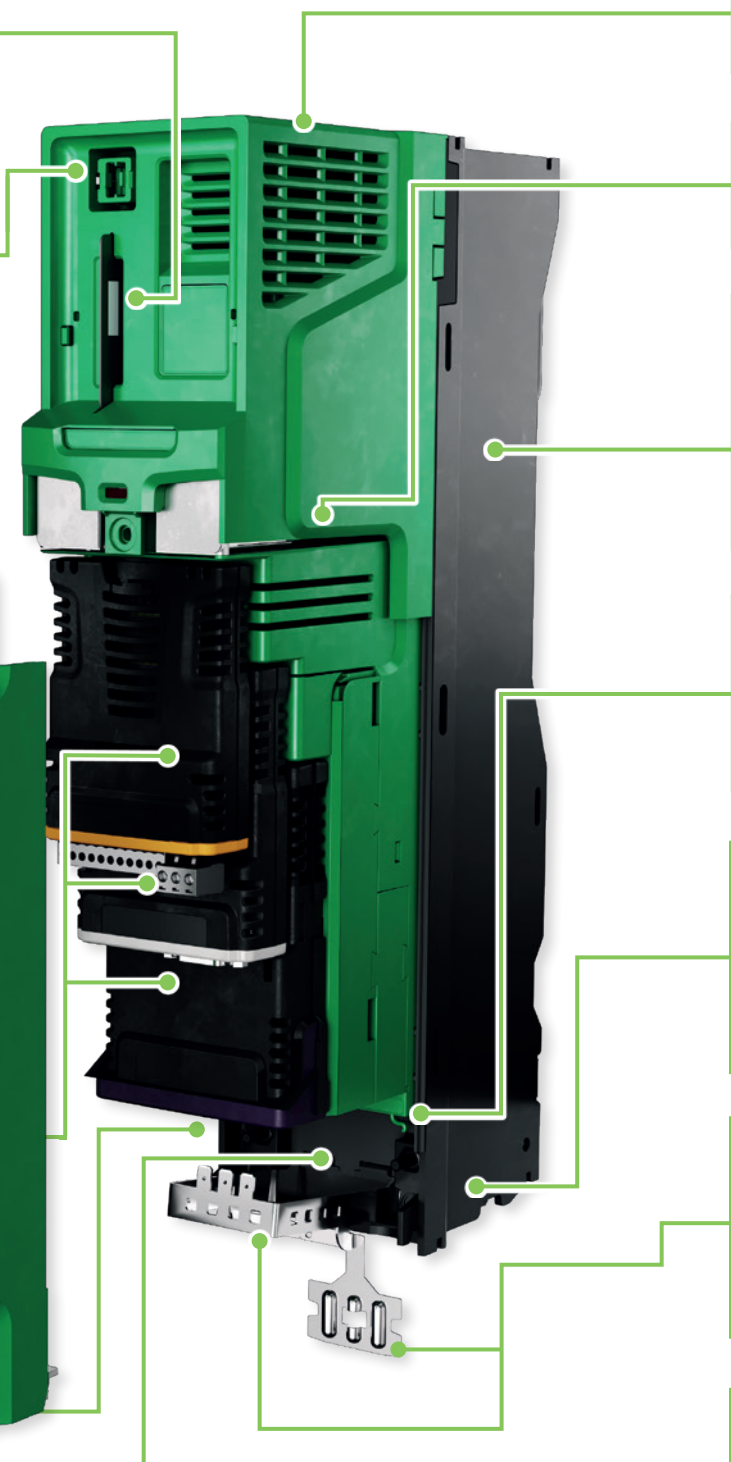

**Onboard EMC filter\***

**Conformal coating as standard**

**Aluminium chassis**

Allows flexible mounting, with high performance extruded heatsink.

**User-friendly power connections**

With removable terminals\*.

**Adaptive multi-speed fan control**

The fan can also be replaced by the user after installation

**Robust cable management system**

Grounding point for shielded control and power cables

**3-pin RS485 Modbus communications as standard**

# Pump Drive F600

## Ordering Guide



### Normal duty operation only

Suitable for pump applications, with a current overload requirement of 110% for 60 s\*.

### Conformance

- IP20 / NEMA1 / UL TYPE 1 \*UL open class as standard, additional kit needed to achieve Type 1
- IP65 / NEMA4 / UL TYPE 12 rating is achieved on the rear of the drive when through panel mounted
- \*Frame size 9D, 9E, 10D and 10E achieve IP55 / NEMA 4 / UL Type 12
- Ambient temperature -20 °C to 40 °C (-4 °F to 104 °F) as standard. Up to 55 °C (131 °F) with derating
- Humidity 95 % maximum (non-condensing) at 40 °C (104 °F)
- Altitude: 0 to 3000 m (9900 ft), derate 1 % per 100 m (330 ft) between 1000 m (3300 ft) and 3000 m (9900 ft)
- Random Vibration Tested in accordance with IEC 60068-2-64
- Bump Tested in accordance with IEC 60068-2-29
- Sinusoidal Vibration Tested in accordance with IEC 60068-2-6
- Mechanical Shock Tested in accordance with IEC 60068-2-29
- Storage temperature -40 °C to 55 °C (-40 °F to 131 °F) or up to 70 °C (158 °F) for short-term storage
- Electromagnetic Immunity complies with EN 61800-3 and EN 61000-6-2
- With onboard EMC filter, emissions comply with EN 61800-3 (category C3)
- EN 61000-6-3 and EN 61000-6-4 with optional footprint EMC filter
- IEC 60146-1-1 Supply conditions (category C1 or C2 depending on rating)
- IEC 61800-5-1 (Electrical Safety)
- IEC 61131-2 I/O
- EN 61000-3-12 with optional line reactor
- UL 508C (Electrical Safety)

\*For more detailed information please see technical documents.

Frame size	Dimensions		Weight
	mm (HxWxD)	in (HxWxD)	
3	382 x 83 x 200	15.0 x 3.3 x 7.9	4.5 (9.9)
	391 x 124 x 200	15.4 x 4.9 x 7.9	6.5 (14.3)
5	391 x 143 x 200	15.4 x 5.6 x 7.6	7.4 (16.3)
6	391 x 210 x 227	15.4 x 8.3 x 8.9	14 (30.9)
7	557 x 270 x 280	21.9 x 10.6 x 11.0	28 (61.7)
8	803 x 310 x 290	31.6 x 12.2 x 11.4	50 (110.2)
9A	1108 x 310 x 290	43.6 x 12.2 x 11.4	66.5 (146.6)
9E/10E	1069 x 310 x 290	42.1 x 12.2 x 11.4	46 (101.4)
9D/10D	Rectifier	Rectifier	12 (26.5)
	355 x 310 x 290	15.8 x 12.2 x 11.4	
11E	Inverter	Inverter	34 (75)
	773 x 310 x 290	30.4 x 12.2 x 11.4	
12T	1242 x 310 x 312	48.9 x 12.2 x 12.3	63 (138.9)
	1750 x 295 x 526	68.9 x 11.6 x 20.7	130 (287)

High IP	Dimensions		Weight
	mm (HxWxD)	in (HxWxD)	
Frame 03	570 x 256 x 225	22.5 x 10.1 x 8.7	7.5 (16.5)
Frame 04	572 x 256 x 221	22.5 x 10.1 x 8.7	9.3 (20.5)
Frame 05	572 x 256 x 221	22.5 x 10.1 x 8.7	10.0 (22.0)
Frame 06	575 x 317 x 248	22.7 x 12.5 x 9.8	16.9 (37.3)



## Keypads

Description	Order code
KI-HOA Keypad RTC F600	82400000021800
Remote HOA Keypad RTC	82400000019700
KI-485 Adaptor	82400000016100

# Product Code Structure

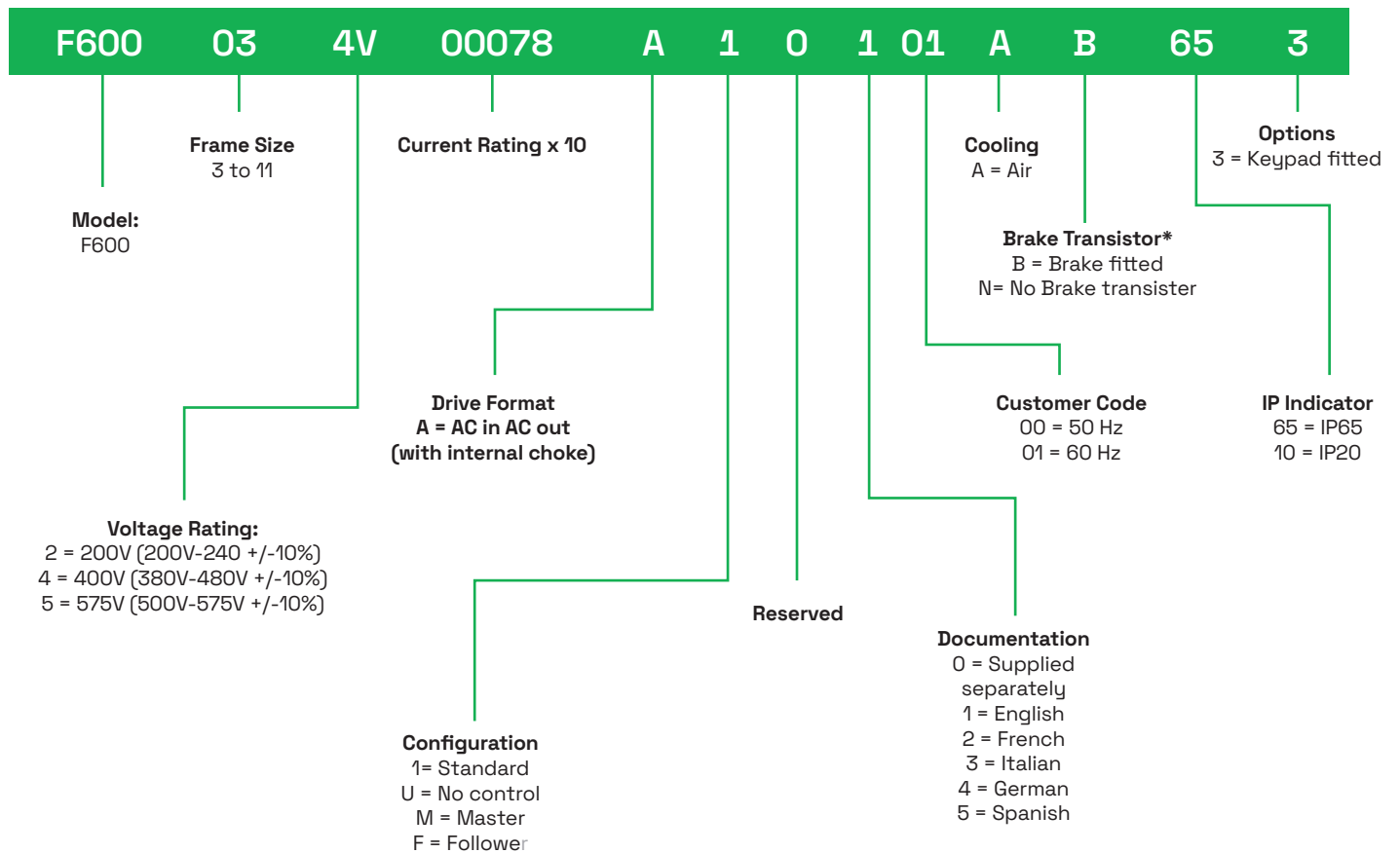

\*B only for frames 3 – 8. N only for frames 9 – 11.

## Manuals

F600 is supplied with a Step-by-Step Setup Guide to assist with fast, efficient commissioning. A detailed user guide is also available to download online, or can be requested from Control Techniques Drive Centres and Partners.

# Pump Drive F600

# Model number and ratings

200/240 Vac ±10%

Product Code	Normal Duty				
	Supply Phases	IP20 Max continuous current (A)*	Motor shaft power (kW)	Motor shaft power (hp)	IP65 Max continuous current (A)**
F600-03200066A	3	6.6	1.1	1.5	6.6
F600-03200080A	3	8	1.5	2	8
F600-03200110A	3	11	2.2	3	11
F600-03200127A	3	12.7	3	3	12.7
F600-04200180A	3	18	4	5	18
F600-04200250A	3	25	5.5	7.5	22
F600-05200300A	3	30	7.5	10	30
F600-06200500A	3	50	11	15	50
F600-06200580A	3	58	15	20	
F600-07200750A	3	75	18.5	25	
F600-07200940A	3	94	22	30	
F600-07201170A	3	117	30	40	
F600-08201490A	3	149	37	50	
F600-08201800A	3	180	45	60	
F600-09202160A	3	216	55	75	
F600-09202660A	3	266	75	100	
F600-09202160E	3	216	55	75	
F600-09202660E	3	266	75	100	
F600-10203250E	3	325	90	125	
F600-10203600E	3	360	110	150	

\* Continuous currents at 2 kHz switching frequency for IP20 models with product codes: F600 (...) 103

\*\* Continuous currents at 2 kHz switching frequency for IP65 models with product codes: F600 (...) 653



## 380/480 Vac ±10%

Product Code	Normal Duty				
	Supply Phases	IP20 Max continuous current (A)*	Motor shaft power (kW)	Motor shaft power (hp)	IP65 Max continuous current (A)**
F600-03400034A	3	3.4	1.1	1.5	3.4
F600-03400045A	3	4.5	1.5	2	4.5
F600-03400062A	3	6.2	2.2	3	6.2
F600-03400077A	3	7.7	3	5	7.7
F600-03400104A	3	10.4	4	5	10.4
F600-03400123A	3	12.3	5.5	7.5	11
F600-04400185A	3	18.5	7.5	10	18.5
F600-04400240A	3	24	11	15	21
F600-05400300A	3	30	15	20	29
F600-06400380A	3	38	18.5	25	38
F600-06400480A	3	48	22	30	48
F600-06400630A	3	63	30	40	
F600-07400790A	3	79	37	50	
F600-07400940A	3	94	45	60	
F600-07401120A	3	112	55	75	
F600-08401550A	3	155	75	100	
F600-08401840A	3	184	90	125	
F600-09402210A	3	221	110	150	
F600-09402660A	3	266	132	200	
F600-09402210E	3	221	110	150	
F600-09402660E	3	266	132	200	
F600-10403200E	3	320	160	250	
F600-10403610E	3	361	200	300	
F600-11404370E	3	437	225	350	
F600-11404870E	3	487	250	400	
F600-11405070E	3	507	280	450	

\* Continuous currents at 2 kHz switching frequency for IP20 models with product codes: F600 (...) 103

\*\* Continuous currents at 2 kHz switching frequency for IP65 models with product codes: F600 (...) 653

500/575 Vac  $\pm 10\%$ 

Product Code	Normal Duty				
	Supply Phases	IP20 Max continuous current (A)*	Motor shaft power (kW)	Motor shaft power (hp)	IP65 Max continuous current (A)**
F600-05500039A	3	3.9	2.2	3	3.9
F600-05500061A	3	6.1	4	5	6.1
F600-05500100A	3	10	5.5	7.5	10
F600-06500120A	3	12	7.5	10	12
F600-06500170A	3	17	11	15	17
F600-06500220A	3	22	15	20	22
F600-06500270A	3	27	18.5	25	27
F600-06500340A	3	34	22	30	34
F600-06500430A	3	43	30	40	
F600-07500530A	3	53	37	50	
F600-07500730A	3	73	45	60	
F600-08500860A	3	86	55	75	
F600-08501080A	3	108	75	100	
F600-09501250A	3	125	90	125	
F600-09501550A	3	155	110	150	
F600-09501250E	3	125	90	125	
F600-09501500E	3	150	110	150	
F600-10502000E	3	200	130	200	
F600-11502480E	3	248	175	250	
F600-11502880E	3	288	225	300	
F600-11503150E	3	315	250	350	

\* Continuous currents at 2 kHz switching frequency for IP20 models with product codes: F600 (...) 103

\*\* Continuous currents at 2 kHz switching frequency for IP65 models with product codes: F600 (...) 653



## 500/690 Vac $\pm 10\%$

Product Code	Normal Duty				
	Supply Phases	IP20 Max continuous current (A)*	Motor shaft power (kW)	Motor shaft power (hp)	IP65 Max continuous current (A)**
F600-07600230A	3	23	18.5	25	
F600-07600300A	3	30	22	30	
F600-07600360A	3	36	30	40	
F600-07600460A	3	46	37	50	
F600-07600520A	3	52	45	60	
F600-07600730A	3	73	55	75	
F600-08600860A	3	86	75	100	
F600-08601080A	3	108	90	125	
F600-09601250A	3	125	110	150	
F600-09601500A	3	150	132	175	
F600-09601250E	3	125	110	150	
F600-09601550E	3	155	132	175	
F600-10601720E	3	172	160	200	
F600-10601970E	3	197	185	250	
F600-11602250E	3	225	200	250	
F600-11602750E	3	275	250	300	
F600-11603050E	3	305	280	400	

\* Continuous currents at 2 kHz switching frequency for IP20 models with product codes: F600 (...) 103

\*\* Continuous currents at 2 kHz switching frequency for IP65 models with product codes: F600 (...) 653

## Frame 12

Product Code*	Frame Size	Heavy Duty					Normal Duty			
		Rated Current (A)	Motor Shaft Power		Peak Current Open Loop (A)	Peak Current RFC (A)	Rated Current (A)	Motor Shaft Power		Peak Current (A)
			(kW)	(HP)				(kW)	(HP)	
<b>380 - 480 V</b>										
M000-12404800T	12	480 *	250	400	672	672	608 *	315	500	668
M000-12405660T	12	566 *	315	450	792	792	660 *	355	550	726
M000-12406600T	12	660 *	355	550	924	924	755 *	400	650	831
M000-12407200T	12	720 *	400	600	1008	1008	865 *	500	700	952
<b>500 - 575 V</b>										
M000-12503150T	12	315 *	250	350	441	441	360 *	250	350	396
M000-12503600T	12	360 *	250	350	504	504	410 *	300	400	451
M000-12504100T	12	410 *	300	400	574	574	460 *	330	450	506
M000-12504600T	12	460 *	330	450	644	644	510 *	370	500	561
<b>500 - 690 V</b>										
M000-12603150T	12	315 *	280	500	441	441	360 *	355	550	396
M000-12603600T	12	360 *	355	550	504	504	410 *	400	600	451
M000-12604100T	12	410 *	400	600	574	574	460 *	450	650	506
M000-12604600T	12	460 *	450	650	644	644	510 *	500	700	561

### Notes:

Frame 12 is only available as an unassigned power module (M000) and an F600 control module must also be ordered

- Internal 125 kW brake chopper included as standard.
- \* Continuous currents at 2 kHz switching frequency
- Implement 2.8 MW drive systems by connecting this module in parallel

For more information on these features and the rest of the capabilities of this module, please see the latest issue of the Modular Power Brochure



# Accessories ordering guide

## Comprehensive options for flexibility

Keypad type	Description
KI-HOA Keypad RTC - Green (Supplied as standard)	 <p>The KI-HOA Keypad RTC provides Hand-Off-Auto control. The display presents up to four lines of real text with multi-language translation, enhancing clarity and increasing ease of use. A battery operated real-time clock allows scheduling of run and off periods and adds accurate time stamping to diagnostics to aid rapid fault resolution</p>
Remote HOA Keypad RTC	 <p>Remote mountable keypad, allowing flexible mounting on the outside of a panel (meets IP54/NEMA 12). The keypad offers Hand-Off-Auto control and can present up to four lines of real text with multi-language translation, enhancing clarity and increasing ease of use. Battery operated real-time clock allows scheduling of run and off periods and adds accurate time stamping to logged events, aiding diagnostics</p>
KI - Keypad Plus (green)	 <p>KI-Keypad Plus's large and clear colour display makes the drive status information and parameter descriptions easy to read and readily accessible. It enables easy access to key drive features for enhanced machine performance, with the helpful wizard quickly guiding the user through configuration.</p> <p>Bluetooth allows remote and flexible connectivity for PC tool commissioning and programming, without needing to open the cabinet, for smarter and safer working. 10 user selectable parameters can be shown on the status screen, with real-time information, plus all parameters can be scaled and their units customised.</p>
KI-485 Adaptor	 <p>This adaptor can be fitted in place of the drive keypad and provides additional ports to communicate via RS485. The adaptor is commonly used for programming the drive.</p>
System Integration Modules - Communications	
SI-Ethernet	 <p>External Ethernet module that supports EtherNet/IP and Modbus TCP/IP and has an integrated web server that can generate emails. The module can be used to provide high speed drive access, global connectivity and integration with IT network technologies, such as wireless networking. To use multiple F600 drives in Multi-leader mode in a parallel pump system, each F600 drive must have an SI-Ethernet module fitted.</p>
SI-EtherCAT	 <p>SI-EtherCAT allows F600 to connect and interface with EtherCAT networks.</p>
SI-PROFINET	 <p>SI-PROFINET allows F600 to communicate and interface with PROFINET PLCs and networks.</p>
SI-PROFIBUS	 <p>PROFIBUS interface module PROFIBUS-DP (Decentralized Peripheral) interface module enables follower connectivity. It is possible to use more than one SI-PROFIBUS or a combination of SI-PROFIBUS and other option modules to add additional functionality such as extended I/O, gateway functionality, or additional PLC features</p>
SI-DeviceNet	 <p>DeviceNet networking system interface module enables follower connectivity. It is possible to use more than one SI-DeviceNet or a combination of SI-DeviceNet and other option modules to provide additional functionality such as extended I/O, gateway functionality, or additional PLC features</p>
SI-CANopen	 <p>CANopen interface module supporting various profiles, including several drive profiles</p>
SI-POWERLINK	 <p>POWERLINK interface module supporting all AC drive families and conforming to the latest POWERLINK standard.</p>
SI-BACnet IP	 <p>The SI-BACnet IP option module provides enhanced control and maximum efficiency in building automation systems, ensuring accurate and co-ordinated operation to boost occupant comfort.</p>
MCi200	 <p>Second processor, providing advanced customisation using standard IEC61131-3 programming languages</p>
MCi210	 <p>Extended advanced machine control using industry standard IEC61131-3 programming languages with simultaneous Connectivity to 2 separate Ethernet networks</p>
Additional I/O and NV media cards	
SI-I/O	 <p>Extended I/O interface module to increase the number of I/O points on a drive. Provides additional: 4 x Digital I/O, 3 x Analog inputs (default)/Digital inputs, 1 x Analog output (default)/Digital input, 2 x Relays</p>
Smartcard	 <p>The optional Smartcard memory device can be used to back-up parameter sets, as well as copying them from one drive to another</p>
SD Card Adaptor	 <p>Conversion device that allows an SD card to be inserted into the Smartcard slot, for parameter cloning and application programs</p>



# Accessories ordering guide

## Retrofit brackets

To allow an F600 to be fitted in existing Unidrive SP and Affinity surface mount installations.

Frame size	Order code
4	3470-0062
5	3470-0066
6	3470-0074
7	3470-0078
8	3470-0087
9A, 9E, & 10	3470-0118

## Through-hole IP65 kits

Frame size	Order code
3	3470-0053
4	3470-0056
5	3470-0067
6	3470-0055
7	3470-0079
8	3470-0083

## Through-hole IP55 kits

Frame size	Order code
9A	3470-0119
9E/10E	3470-0105
10 Inverter	3470-0108
10 Rectifier	3470-0106
11E & 11T	3470-0126
11D Inverter	3470-0130
11 Rectifier	3470-0123

## Option modules

Option module	Order code
SI-PROFIBUS	82400000017500
SI-Ethernet	82400000017900
SI-EtherCAT	82400000018000
SI-DeviceNet	82400000017700
SI-CANopen	82400000017600
SI-POWERLINK	82400000021600
SI-PROFINET RT	82500000018200
KI-KEYPAD PLUS	82400000022600
MCi200	82400000017000
MCi210	82400000016700
SI-I/O	82400000017800

## Tile mount kit

Frame size	Order code
3	3470-0049
4	3470-0060
5	3470-0073

## General kit items

Item	Order code
Frame size 3 & 4 power connector split kit	3470-0064

## Optional media and accessories

Description	Order code
SD-Smartcard Adaptor	3470-0047
Smartcard (64KB)	2214-0010

# Accessories ordering guide

## DC bus paralleling kits

Frame size	Order code
3	3470-0048
4	3470-0061
5	3470-0068
6	3470-0063
6 (connect to frame 3,4 & 5)	3470-0111

## Line reactors

Frame size	Order code
9E 200 V/400 V	4401-0181
9E 575 V/690 V	4401-0183
10E 200 V/400 V	4401-0182
10E 575 V/690 V	4401-0184

## UL type 1 conduit kits

Frame size	Order code
3&4	6521-0071
5	3470-0069
6	3470-0059
7	3470-0080
8 & 9A	6500-0106
9E & 10E	3470-0115
11	3470-0136

## Optional external EMC filters

The F600's built-in EMC filter complies with EN 61800-3\*. External EMC filters are required for compliance with EN 61000-6-4.

Frame size	Voltage	Order code
3	200 V	4200-3230
	400 V	4200-3480
4	200 V	4200-0272
	400 V	4200-0252
5	200 V	4200-0312
	400 V	4200-0402
	575 V	4200-0122
6	200 V	4200-2300
	400 V	4200-4800
	575 V	4200-3690
7	200 V	4200-1132
	400 V	4200-1132
	575 V	4200-0672
	690 V	4200-0672
8	200 V	4200-1972
	400 V	4200-1972
	575 V	4200-1662
9A	690 V	4200-1662
	200 V	4200-3021
	400 V	4200-3021
	575 V	4200-1660
9E & 10E	690 V	4200-1660
	200 V	4200-4460
	400 V	4200-4460
	575 V	4200-2210
11	690 V	4200-2210
	400 V	4200-0400
	575 V & 690 V	4200-0690

\*For more detailed information please see technical documents.



**Nidec**

Autom

Innovatin  
environn  
comfort

# The world's leading global manufacturer of electric motors and controls

Nidec, the world's largest motor brand.

**Nidec is in everything, everywhere.**

If you drive a car, wash your clothes, watch movies or talk on a smartphone, you're using Nidec technology. Almost anything that spins and moves, no matter how big or small, does so thanks to a Nidec product.

Our shared values of passion, enthusiasm and tenacity guide us on our collective journey to be the best.



## Appliance, commercial & industrial motors

Energy efficient motor and drive technology for commercial, industrial, and home appliances



## Automotive

Working to help improve safety, environmental protection and performance required for automobiles



## Small precision motors

DC motors for all industries and applications



## Motion & Energy

High-performance motors, drives, generators & energy management solutions for renewables, automation, infrastructure, and electric vehicles

## Machinery

Machines, factory automation equipment, measuring, and testing devices



Connect with us



[www.controltechniques.com](http://www.controltechniques.com)

[www.kbelectronics.com](http://www.kbelectronics.com)

©2024 Nidec Control Techniques Limited. The information contained in this brochure is for guidance only and does not form part of any contract. The accuracy cannot be guaranteed as Nidec Control Techniques Ltd have an ongoing process of development and reserve the right to change the specification of their products without notice.

Nidec Control Techniques Limited. Registered Office: The Gro, Newtown, Powys SY16 3BE.

Registered in England and Wales. Company Reg. No. 01236886.

